

Color	Type	Technology	Angle of Half Intensity $\pm\varphi$
Red	TLWR76..	AllnGaP on GaAs	30°
Yellow	TLWY76..	AllnGaP on GaAs	30°
True Green	TLWTG76..	InGaN on SiC	30°
Blue Green	TLWBG76..	InGaN on SiC	30°
Blue	TLWB76..	InGaN on SiC	30°
White	TLWW76..	InGaN / YAG on SiC	30°

Description

The TELUX™ series is a clear, non diffused LED for high end applications where supreme luminous flux is required.

It is designed in an industry standard 7.62 mm square package utilizing highly developed (AS) AllnGaP and InGaN technologies.

The supreme heat dissipation of TELUX™ allows applications at high ambient temperatures.

All packing units are binned for luminous flux and color to achieve best homogenous light appearance in application.

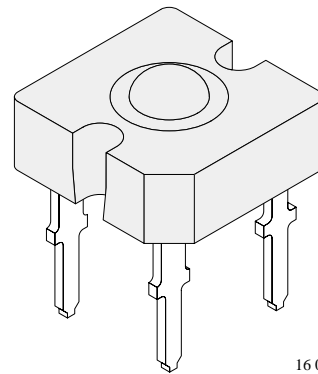

16 012

Features

- Utilizing (AS) AllnGaP and InGaN technologies
- High luminous flux
- Supreme heat dissipation: R_{thJP} is 90 K/W
- High operating temperature: T_j up to + 125 °C
- Type TLWR meets SAE and ECE color requirements
- Packed in tubes for automatic insertion
- Luminous flux and color categorized for each tube
- Small mechanical tolerances allow precise usage of external reflectors or lightguides
- TLWR types additionally forward voltage categorized

Applications

Exterior lighting
 Dashboard illumination
 Tail-, Stop – and Turn Signals of motor vehicles
 Replaces incandescent lamps
 Traffic signals and signs

Absolute Maximum Ratings

$T_{amb} = 25^{\circ}\text{C}$, unless otherwise specified

TLWR76.. , TLWY76..

Parameter	Test Conditions	Type	Symbol	Value	Unit
Reverse voltage	$I_R = 10\mu\text{A}$	TLWR76..	V_R	10	V
DC forward current	$T_{amb} \leq 85^{\circ}\text{C}$		I_F	70	mA
Surge forward current	$t_p \leq 10 \mu\text{s}$	TLWY76..	I_{FSM}	1	A
Power dissipation	$T_{amb} \leq 85^{\circ}\text{C}$		P_V	187	mW
Junction temperature			T_j	125	$^{\circ}\text{C}$
Operating temperature range			T_{amb}	-40 to +110	$^{\circ}\text{C}$
Storage temperature range			T_{stg}	-55 to +110	$^{\circ}\text{C}$
Soldering temperature	$t \leq 5 \text{ s}$, 1.5 mm from body preheat temperature $100^{\circ}\text{C}/30\text{sec}$.		T_{sd}	260	$^{\circ}\text{C}$
Thermal resistance junction/ambient	with cathode heatsink of 70 mm^2		R_{thJA}	200	K/W

$T_{amb} = 25^{\circ}\text{C}$, unless otherwise specified

TLWTG76.. , TLWBG76.. , TLWB76.. , TLWW76..

Parameter	Test Conditions	Type	Symbol	Value	Unit
Reverse voltage	$I_R = 10\mu\text{A}$	TLWTG76..	V_R	5	V
DC forward current	$T_{amb} \leq 50^{\circ}\text{C}$	TLWBG76..	I_F	50	mA
Surge forward current	$t_p \leq 10 \mu\text{s}$	TLWB76..			
Power dissipation	$T_{amb} \leq 50^{\circ}\text{C}$	TLWW76..	I_{FSM}	0.1	A
Power dissipation	$T_{amb} \leq 50^{\circ}\text{C}$	TLWTG76..	P_V	230	mW
		TLWBG76..			
		TLWB76..			
		TLWW76..	P_V	255	mW
Junction temperature			T_j	100	$^{\circ}\text{C}$
Operating temperature range			T_{amb}	-40 to +100	$^{\circ}\text{C}$
Storage temperature range			T_{stg}	-55 to +100	$^{\circ}\text{C}$
Soldering temperature	$t \leq 5 \text{ s}$, 1.5 mm from body preheat temperature $100^{\circ}\text{C}/30\text{sec}$.		T_{sd}	260	$^{\circ}\text{C}$
Thermal resistance junction/ambient	with cathode heatsink of 70 mm^2		R_{thJA}	200	K/W

**Optical and Electrical Characteristics** $T_{amb} = 25^{\circ}\text{C}$, unless otherwise specified**Red (TLWR76..)**

Parameter	Test Conditions	Type	Symbol	Min	Typ	Max	Unit
Total flux	$I_F = 70\text{ mA}$, $R_{thJA} = 200^{\circ}\text{K/W}$		ϕ_V	1500	2100	3000	mIm
Luminous intensity/ Total flux			I_V/ϕ_V		0.8		mcd/ mIm
Dominant wavelength			λ_d	611	616	634	nm
Peak wavelength			λ_p		624		nm
Angle of half intensity			ϕ		± 30		deg
Total included angle	90 % of Total Flux Captured		$\phi_{0.9V}$		75		deg
Forward voltage	$I_F = 70\text{ mA}$, $R_{thJA} = 200^{\circ}\text{K/W}$		V_F	1.83	2.2	2.67	V
Reverse voltage	$I_R = 10\ \mu\text{A}$		V_R	10	20		V
Junction capacitance	$V_R = 0$, $f = 1\text{ MHz}$		C_j		17		pF

Yellow (TLWY76..)

Parameter	Test Conditions	Type	Symbol	Min	Typ	Max	Unit
Total flux	$I_F = 70\text{ mA}$, $R_{thJA} = 200^{\circ}\text{K/W}$		ϕ_V	1000	1400	2400	mIm
Luminous intensity/ Total flux			I_V/ϕ_V		0.8		mcd/ mIm
Dominant wavelength			λ_d	585	590	597	nm
Peak wavelength			λ_p		594		nm
Angle of half intensity			ϕ		± 30		deg
Total included angle	90 % of Total Flux Captured		$\phi_{0.9V}$		75		deg
Forward voltage	$I_F = 70\text{ mA}$, $R_{thJA} = 200^{\circ}\text{K/W}$		V_F	1.83	2.1	2.67	V
Reverse voltage	$I_R = 10\ \mu\text{A}$		V_R	10	15		V
Junction capacitance	$V_R = 0$, $f = 1\text{ MHz}$		C_j		32		pF

True Green (TLWTG76..)

Parameter	Test Conditions	Type	Symbol	Min	Typ	Max	Unit
Total flux	$I_F = 50\text{ mA}$, $R_{thJA} = 200^{\circ}\text{K/W}$		ϕ_V	630	900	1800	mIm
Luminous intensity/ Total flux			I_V/ϕ_V		0.8		mcd/ mIm
Dominant wavelength			λ_d	509	521	529	nm
Peak wavelength			λ_p		520		nm
Angle of half intensity			ϕ		± 30		deg
Total included angle	90 % of Total Flux Captured		$\phi_{0.9V}$		75		deg
Forward voltage	$I_F = 50\text{ mA}$, $R_{thJA} = 200^{\circ}\text{K/W}$		V_F		4.2	4.7	V
Reverse voltage	$I_R = 10\ \mu\text{A}$		V_R	5	10		V
Junction capacitance	$V_R = 0$, $f = 1\text{ MHz}$		C_j		50		pF

Blue Green (TLWBG76..)

Parameter	Test Conditions	Type	Symbol	Min	Typ	Max	Unit
Total flux	$I_F = 50 \text{ mA}, R_{thJA} = 200 \text{ }^\circ\text{K/W}$		ϕ_V	400	700	1250	mlm
Luminous intensity/ Total flux			I_V/ϕ_V		0.8		mcd/ mlm
Dominant wavelength			λ_d	492	505	510	nm
Peak wavelength			λ_p		503		nm
Angle of half intensity			ϕ		± 30		deg
Total included angle	90 % of Total Flux Captured		$\phi_{0.9V}$		75		deg
Forward voltage	$I_F = 50 \text{ mA}, R_{thJA} = 200 \text{ }^\circ\text{K/W}$		V_F		4.2	4.7	V
Reverse voltage	$I_R = 10 \text{ } \mu\text{A}$		V_R	5	10		V
Junction capacitance	$V_R = 0, f = 1 \text{ MHz}$		C_j		50		pF

Blue (TLWB76..)

Parameter	Test Conditions	Type	Symbol	Min	Typ	Max	Unit
Total flux	$I_F = 50 \text{ mA}, R_{thJA} = 200 \text{ }^\circ\text{K/W}$		ϕ_V	200	330	630	mlm
Luminous intensity/ Total flux			I_V/ϕ_V		0.8		mcd/ mlm
Dominant wavelength			λ_d	462	470	476	nm
Peak wavelength			λ_p		465		nm
Angle of half intensity			ϕ		± 30		deg
Total included angle	90 % of Total Flux Captured		$\phi_{0.9V}$		75		deg
Forward voltage	$I_F = 50 \text{ mA}, R_{thJA} = 200 \text{ }^\circ\text{K/W}$		V_F		4.3	4.7	V
Reverse voltage	$I_R = 10 \text{ } \mu\text{A}$		V_R	5	10		V
Junction capacitance	$V_R = 0, f = 1 \text{ MHz}$		C_j		50		pF

White (TLWW76..)

Parameter	Test Conditions	Type	Symbol	Min	Typ	Max	Unit
Total flux	$I_F = 50 \text{ mA}, R_{thJA} = 200 \text{ }^\circ\text{K/W}$		ϕ_V	400	650	1250	mlm
Luminous intensity/ Total flux			I_V/ϕ_V		0.8		mcd/ mlm
Color temperature			T_K		5500		K
Angle of half intensity			ϕ		± 30		deg
Total included angle		90 % of Total Flux Captured		$\phi_{0.9V}$		75	
Forward voltage	$I_F = 50 \text{ mA}, R_{thJA} = 200 \text{ }^\circ\text{K/W}$		V_F		4.3	5.1	V
Reverse voltage	$I_R = 10 \text{ } \mu\text{A}$		V_R	5	10		V
Junction capacitance	$V_R = 0, f = 1 \text{ MHz}$		C_j		50		pF

Typical Characteristics ($T_{amb} = 25^{\circ}\text{C}$, unless otherwise specified)

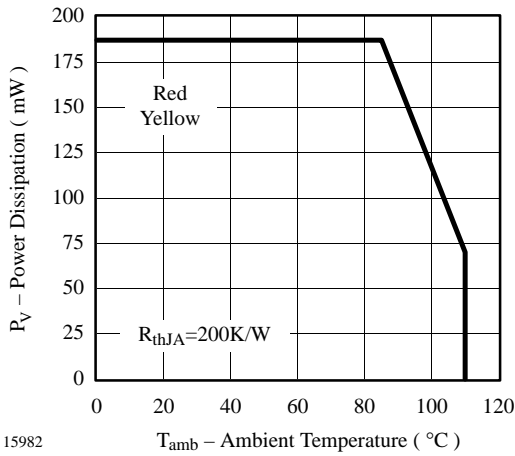

15982

Figure 1 Power Dissipation vs. Ambient Temperature

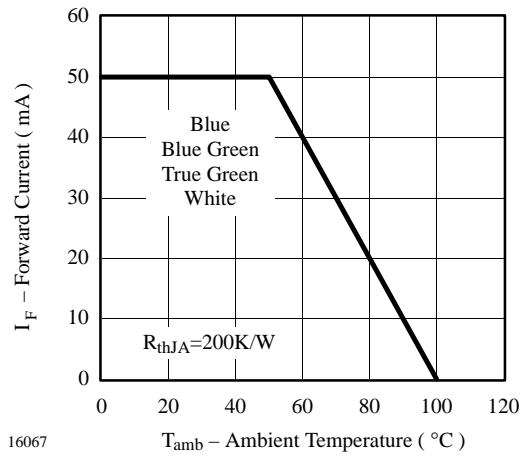

16067

Figure 4 Forward Current vs. Ambient Temperature

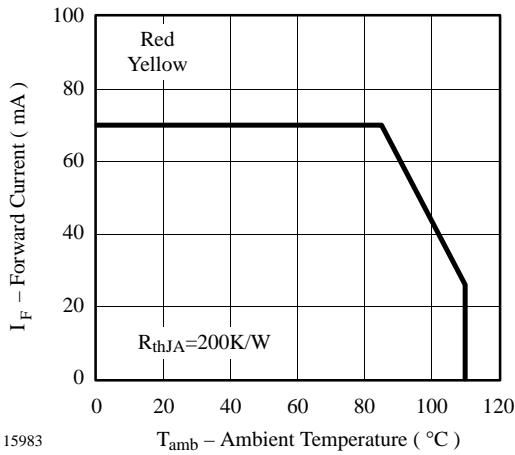

15983

Figure 2 Forward Current vs. Ambient Temperature

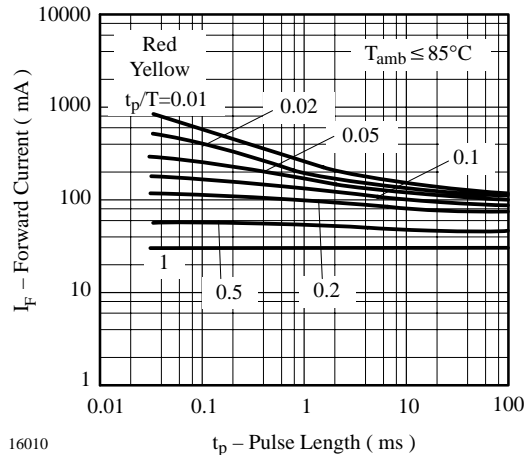

16010

Figure 5 Forward Current vs. Pulse Length

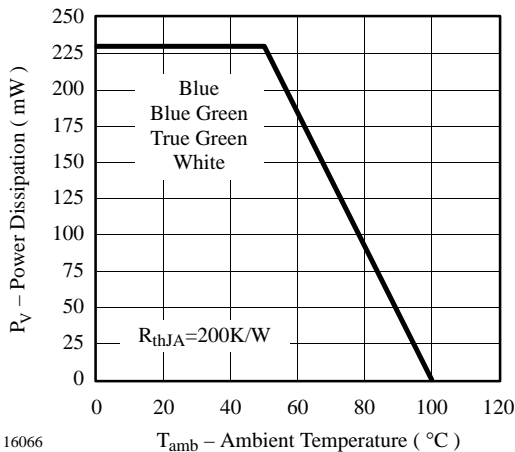

16066

Figure 3 Power Dissipation vs. Ambient Temperature

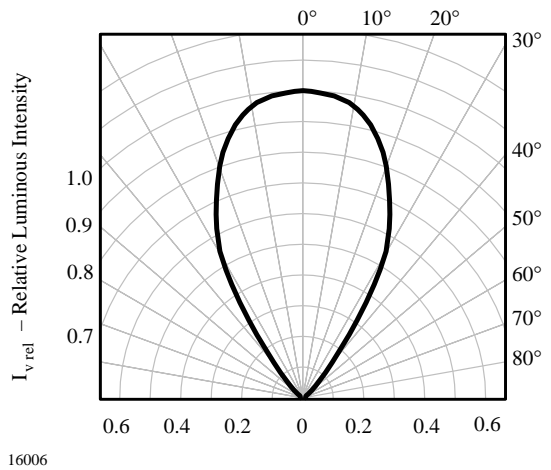

16006

Figure 6 Rel. Luminous Intensity vs. Angular Displacement

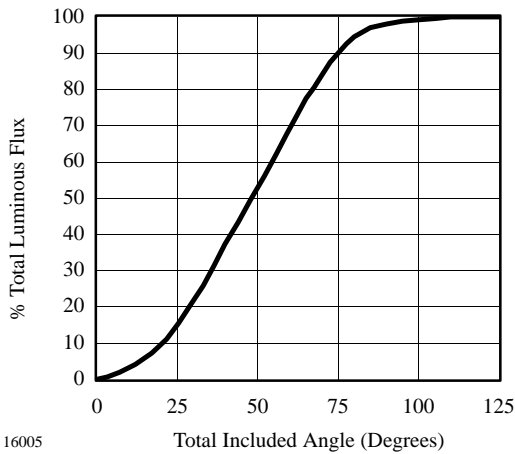

16005

Figure 7 Percentage Total Luminous Flux vs. Total Included Angle (Degrees)

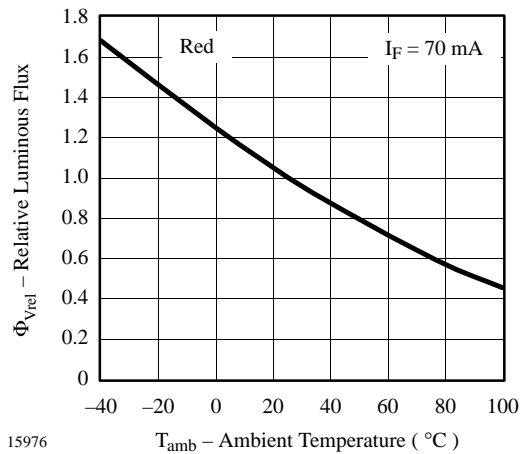

15976

Figure 10 Rel. Luminous Flux vs. Ambient Temperature

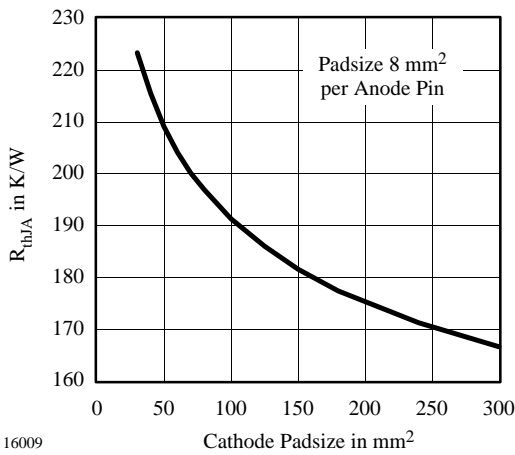

16009

Figure 8 Thermal Resistance Junction Ambient vs. Cathode Padsizes

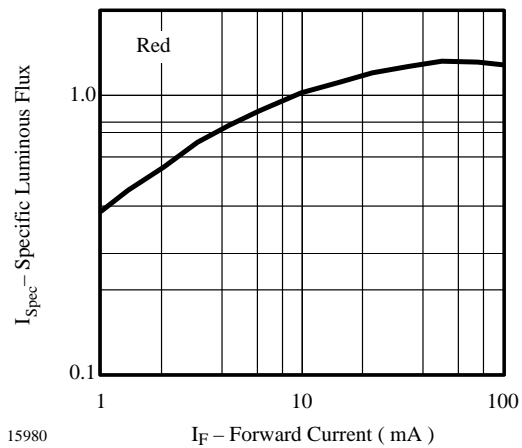

15980

Figure 11 Specific Luminous Flux vs. Forward Current

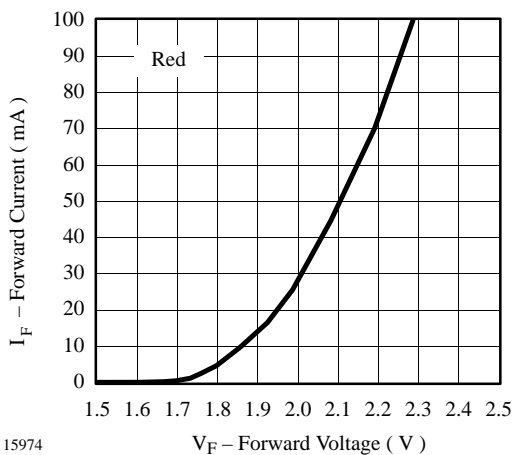

15974

Figure 9 Forward Current vs. Forward Voltage

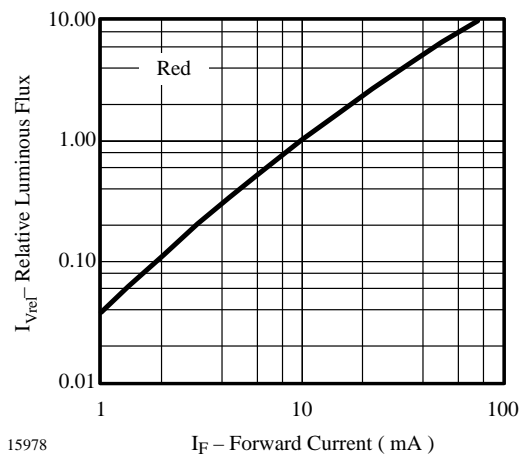

15978

Figure 12 Relative Luminous Flux vs. Forward Current

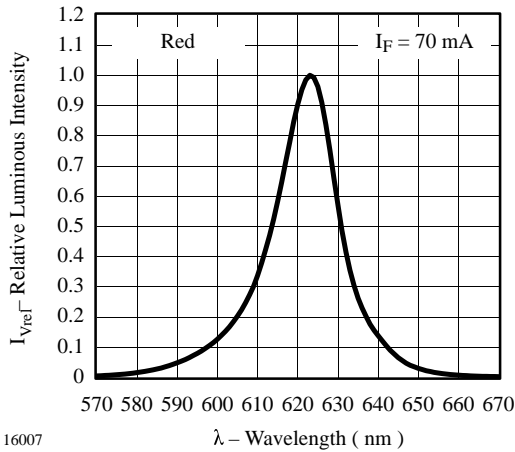

Figure 13 Relative Luminous Intensity vs. Wavelength

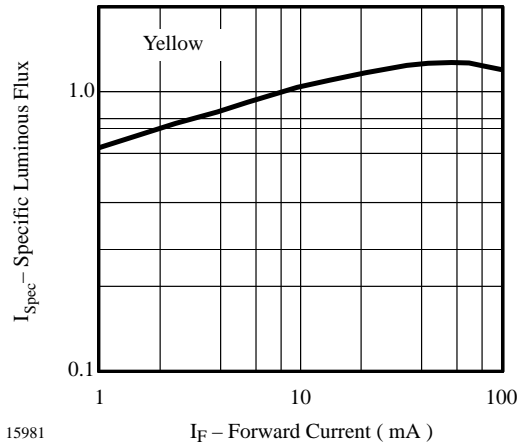

Figure 16 Specific Luminous Flux vs. Forward Current

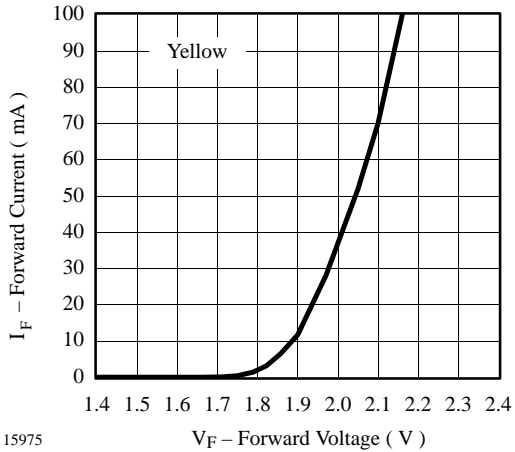

Figure 14 Forward Current vs. Forward Voltage

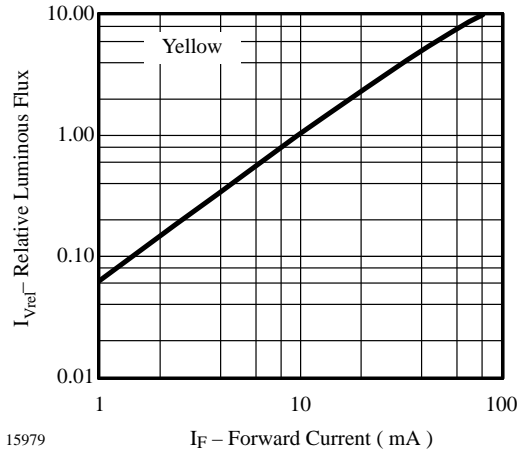

Figure 17 Relative Luminous Flux vs. Forward Current

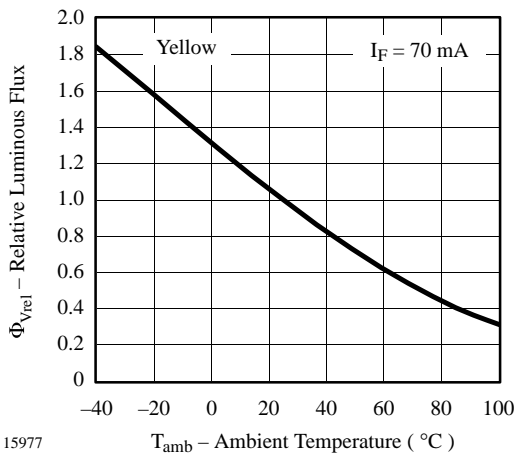

Figure 15 Rel. Luminous Flux vs. Ambient Temperature

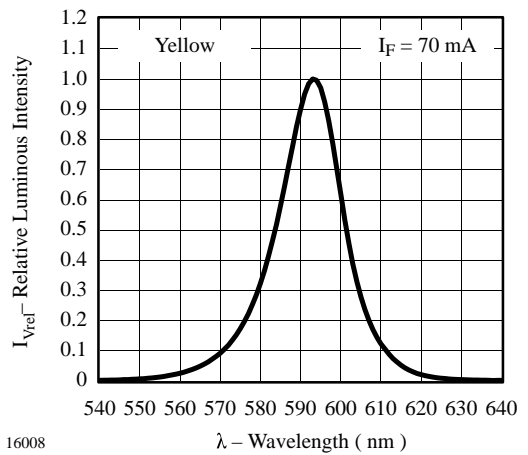
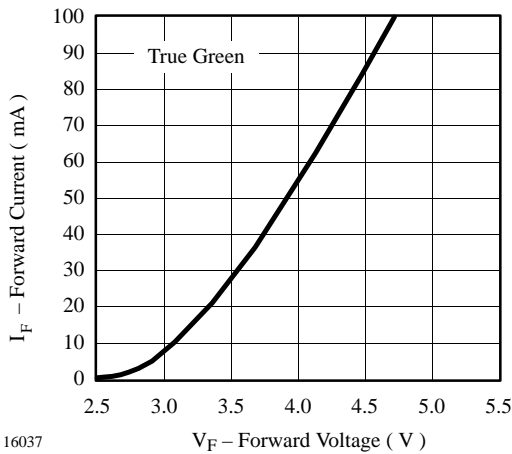
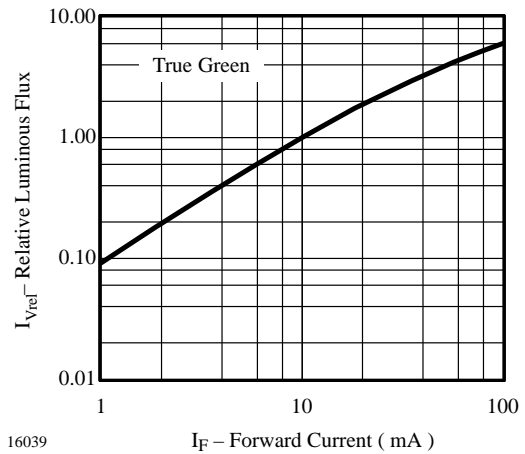

Figure 18 Relative Luminous Intensity vs. Wavelength



16037

Figure 19 Forward Current vs. Forward Voltage



16039

Figure 22 Relative Luminous Flux vs. Forward Current

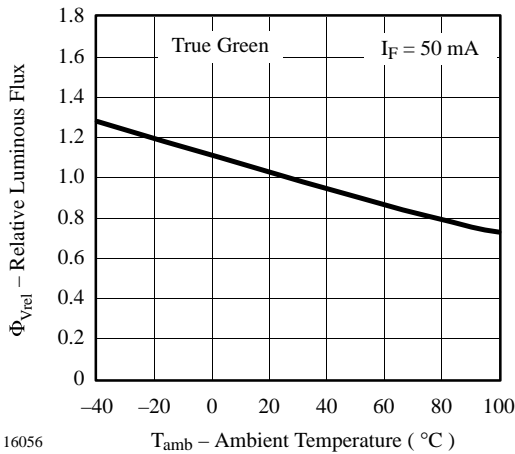

16056

Figure 20 Rel. Luminous Flux vs. Ambient Temperature

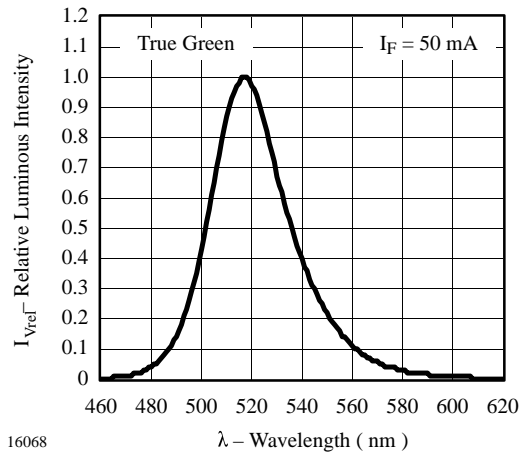

16068

Figure 23 Relative Luminous Intensity vs. Wavelength

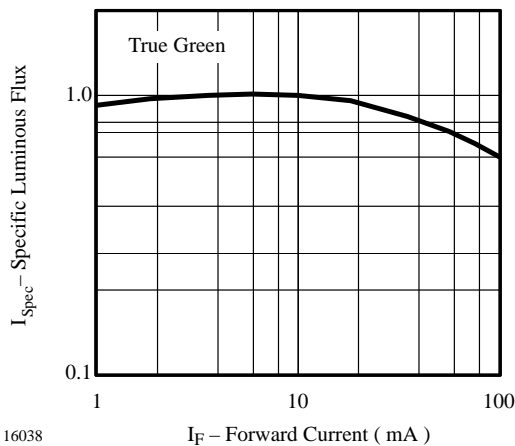

16038

Figure 21 RSpecific Luminous Flux vs. Forward Current

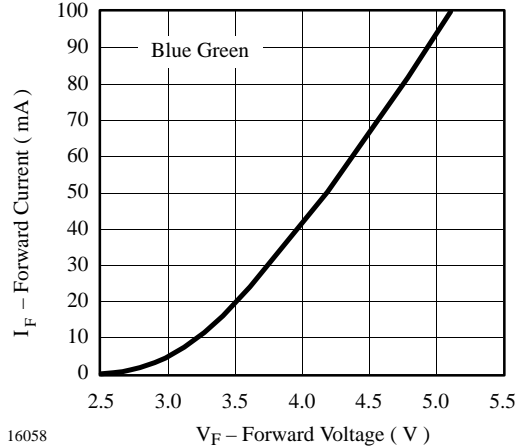

16058

Figure 24 Forward Current vs. Forward Voltage

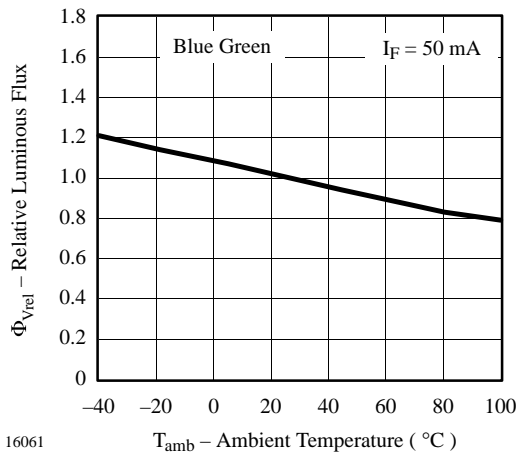

Figure 25 Rel. Luminous Flux vs. Ambient Temperature

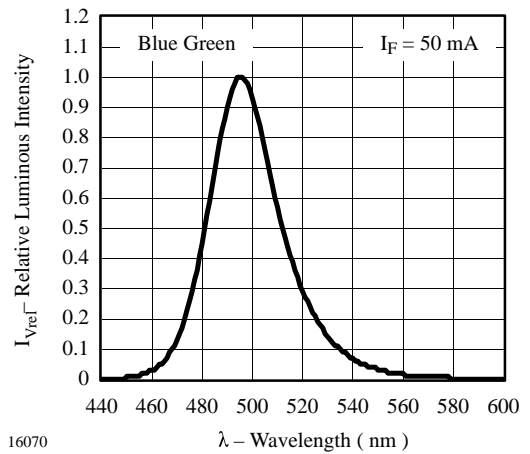

Figure 28 Relative Luminous Intensity vs. Wavelength

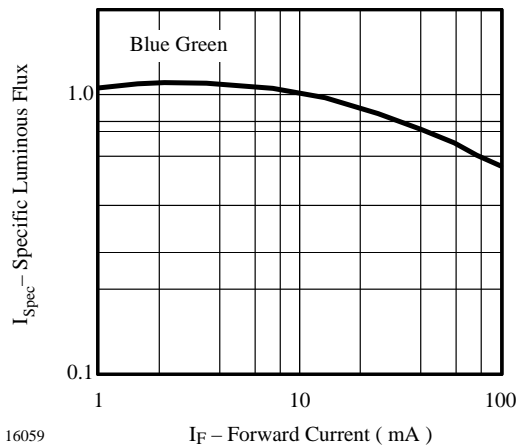

Figure 26 Specific Luminous Flux vs. Forward Current

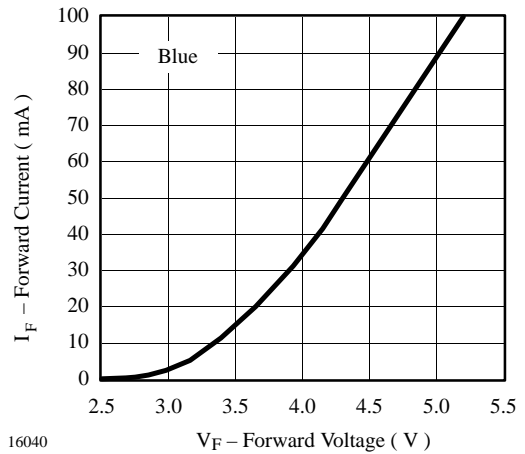

Figure 29 Forward Current vs. Forward Voltage

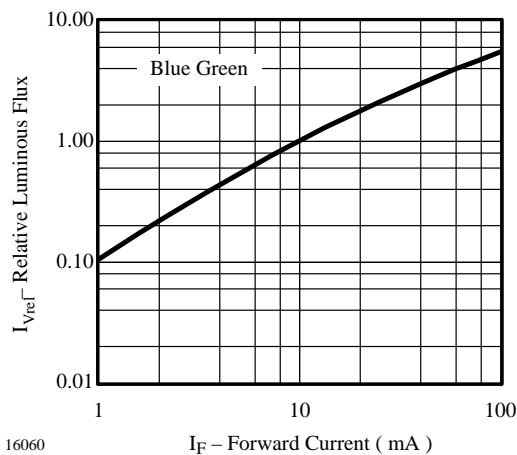

Figure 27 Relative Luminous Flux vs. Forward Current

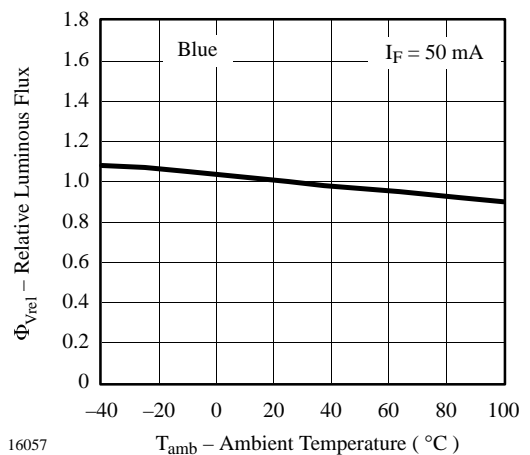
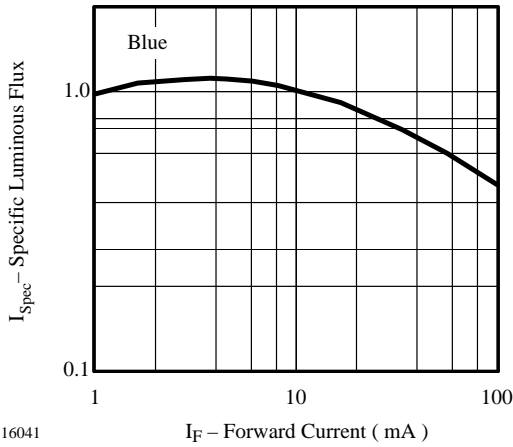
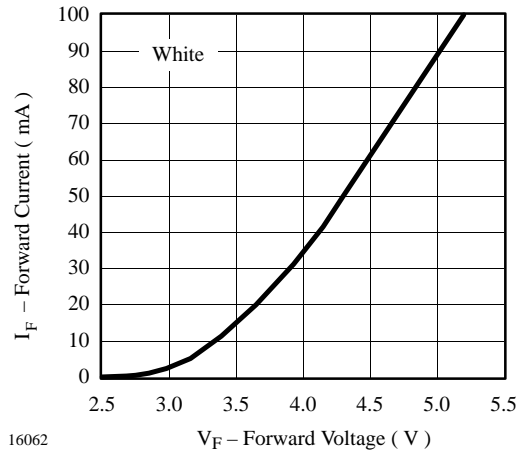

Figure 30 Rel. Luminous Flux vs. Ambient Temperature



16041

Figure 31 Specific Luminous Flux vs. Forward Current



16062

Figure 34 Forward Current vs. Forward Voltage

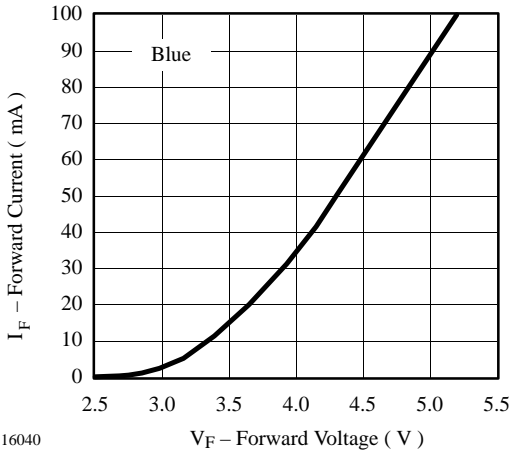

16040

Figure 32 Forward Current vs. Forward Voltage

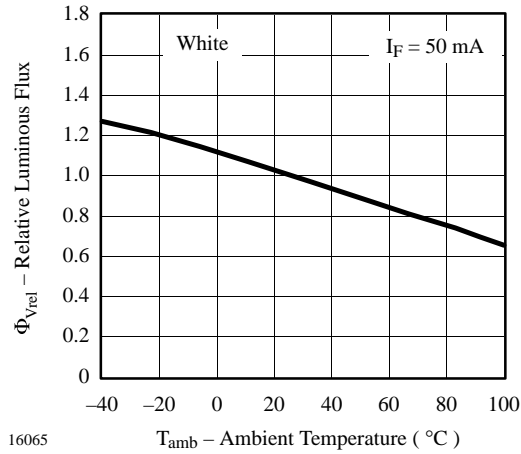

16065

Figure 35 Rel. Luminous Flux vs. Ambient Temperature

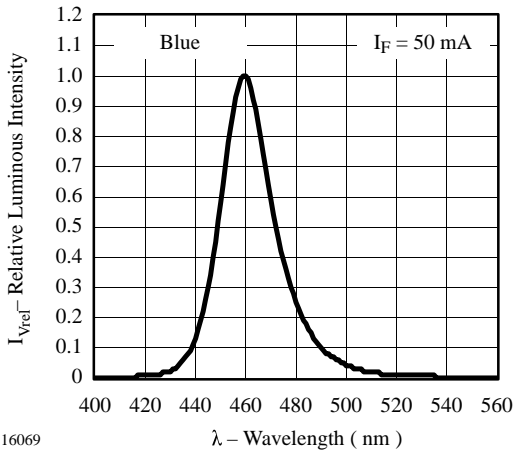

16069

Figure 33 Relative Luminous Intensity vs. Wavelength

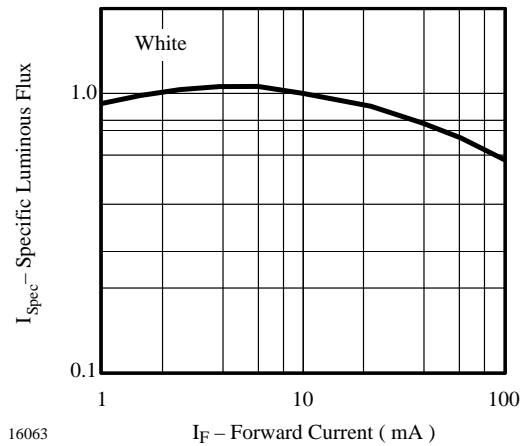

16063

Figure 36 Specific Luminous Flux vs. Forward Current

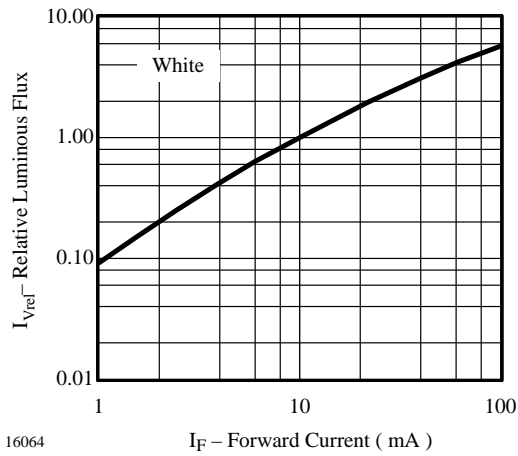

Figure 37 Rel. Luminous Flux vs. Ambient Temperature

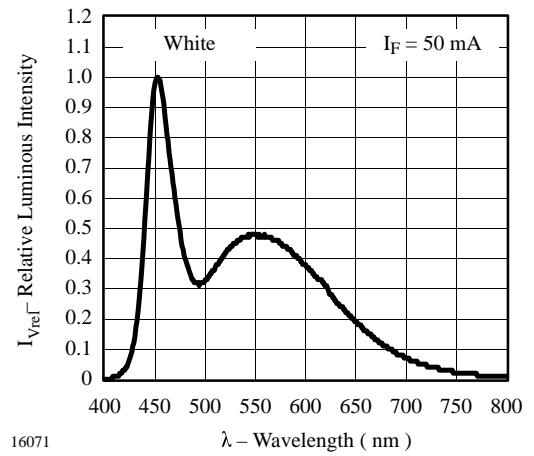
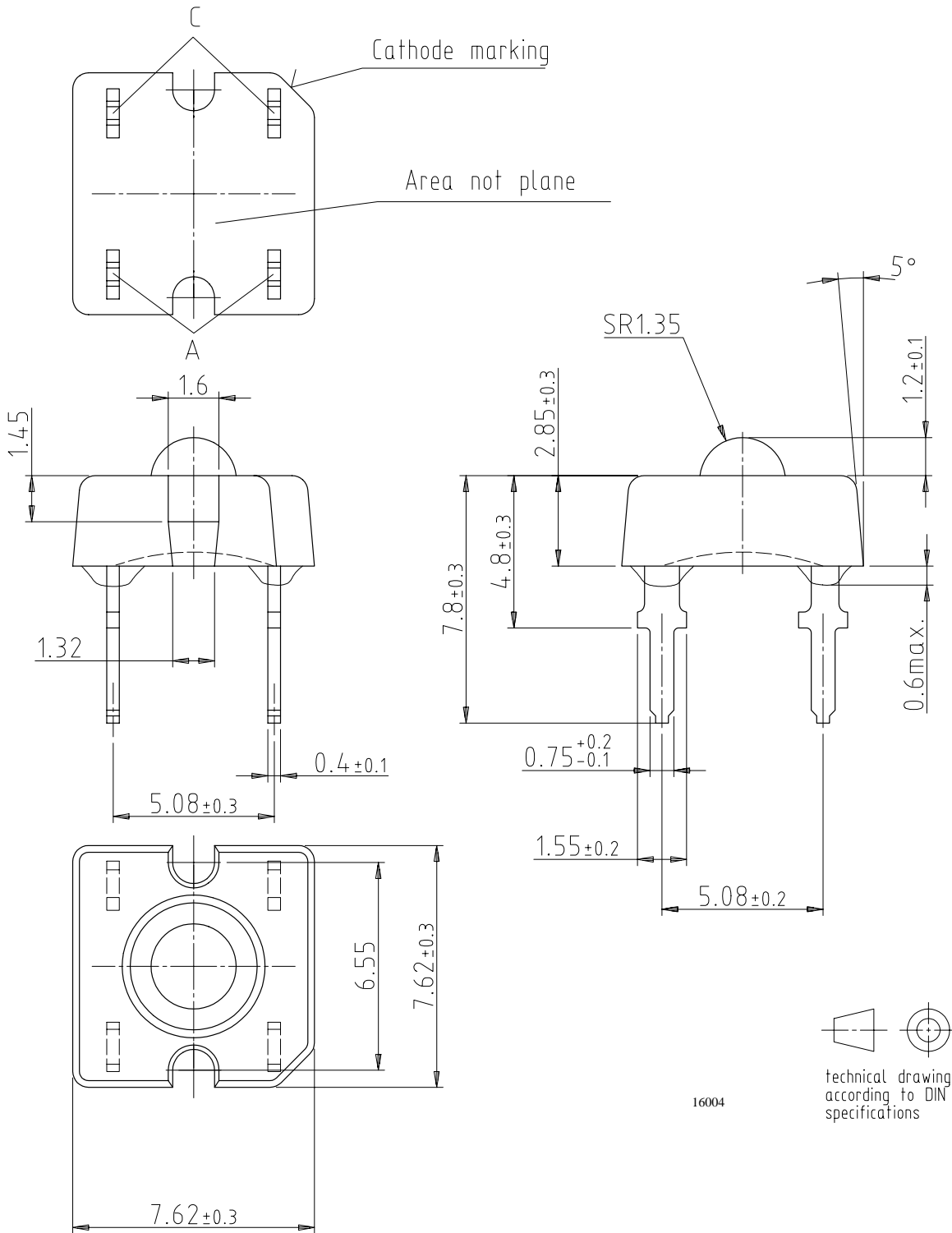

Figure 38 Specific Luminous Flux vs. Forward Current

Dimensions in mm





Ozone Depleting Substances Policy Statement

It is the policy of **Vishay Semiconductor GmbH** to

1. Meet all present and future national and international statutory requirements.
2. Regularly and continuously improve the performance of our products, processes, distribution and operating systems with respect to their impact on the health and safety of our employees and the public, as well as their impact on the environment.

It is particular concern to control or eliminate releases of those substances into the atmosphere which are known as ozone depleting substances (ODSs).

The Montreal Protocol (1987) and its London Amendments (1990) intend to severely restrict the use of ODSs and forbid their use within the next ten years. Various national and international initiatives are pressing for an earlier ban on these substances.

Vishay Semiconductor GmbH has been able to use its policy of continuous improvements to eliminate the use of ODSs listed in the following documents.

1. Annex A, B and list of transitional substances of the Montreal Protocol and the London Amendments respectively
2. Class I and II ozone depleting substances in the Clean Air Act Amendments of 1990 by the Environmental Protection Agency (EPA) in the USA
3. Council Decision 88/540/EEC and 91/690/EEC Annex A, B and C (transitional substances) respectively.

Vishay Semiconductor GmbH can certify that our semiconductors are not manufactured with ozone depleting substances and do not contain such substances.

We reserve the right to make changes to improve technical design and may do so without further notice.

Parameters can vary in different applications. All operating parameters must be validated for each customer application by the customer. Should the buyer use Vishay-Telefunken products for any unintended or unauthorized application, the buyer shall indemnify Vishay-Telefunken against all claims, costs, damages, and expenses, arising out of, directly or indirectly, any claim of personal damage, injury or death associated with such unintended or unauthorized use.

Vishay Semiconductor GmbH, P.O.B. 3535, D-74025 Heilbronn, Germany
Telephone: 49 (0)7131 67 2831, Fax number: 49 (0)7131 67 2423